

Fish bite alarm FISHTRON Q10 TX MANUAL

(last updated 2/1/2024)

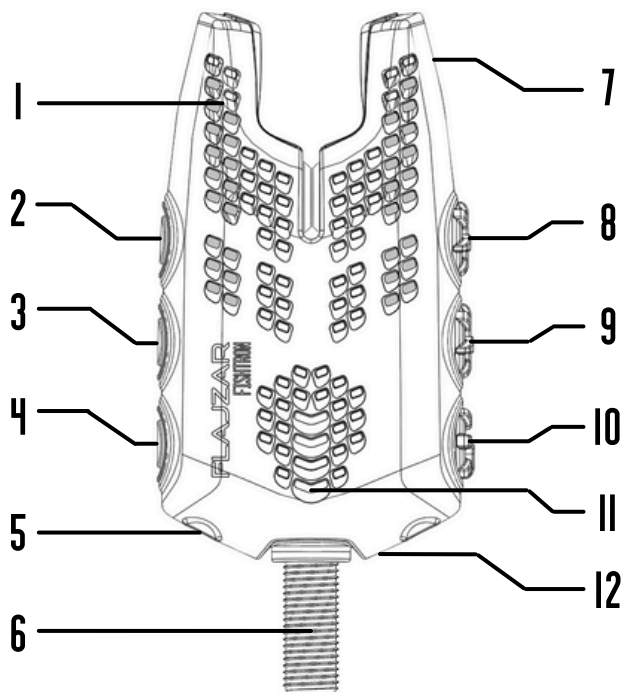

Thank you for purchasing FISHTRON Q10 TX fish bite alarm. We are very pleased that you have chosen our product and believe that you will be satisfied with it.



- | | |
|---|--|
| <p>1 COLORED LED COLUMNS
Signaling of the direction of the fishing-line unwinding with a memory</p> <p>2 ON/OFF BUTTON
Long press turns on/off the alarm
A short press turns the MUTE function on/off
A very long press turns on the CONNECT function</p> <p>3 LED BUTTON
Long press activates the color setting mode
Short press sets the LED brightness level in 6 steps from 0 to 100% brightness</p> <p>4 ALARM BUTTON
Long press turns on/off the INFRARED BARRIER
Short press turns on/off the position LED</p> <p>5 CONNECTOR
To connect a swinger</p> <p>6 FIXING SCREW</p> | <p>7 INFRARED BARRIER
Rod theft protection, can be switched on and off</p> <p>8 SENSITIVITY ADJUSTMENT
Forward highest sensitivity (longest line cover)
Backward lowest sensitivity (shortest line cover)</p> <p>9 TONE ADJUSTMENT
Forward lowest note
Backward highest note</p> <p>10 VOLUME ADJUSTMENT
Forward decreases volume
Backward increases volume</p> <p>11 SOUND
Acoustic signaling of the direction of the fishing-line unwinding</p> <p>12 BATTERY REPLACEMENT 2x AAA (2x 1.5V)
Remove the battery cover on the back of the alarm</p> |
|---|--|

Switching ON/OFF the alarm:

Turn ON the alarm:

Long press ON/OFF button (2 sec.), the LED columns light up from the bottom to the top and turn on for 5 sec. The current battery status is displayed using red LEDs for 5 sec. (51%-100% - the full LED column lights up, 26%- 50 % - half LED column is lit, below 25% - lower LED is lit - batteries must be replaced).

Turn OFF the alarm:

Long press ON/OFF button (2 sec.), the LED column lights up from top to bottom.

MUTE function (temporary switching off sounds and broadcast):

Turn ON the MUTE function:

Short press the top ON/OFF button while the bite alarm is on. The MUTE function is indicated by the flashing of the middle two LEDs.

Turn OFF the MUTE function:

The function is canceled automatically 60 sec. after the function is turned on, or it can be turned off by pressing the ON/OFF button again.

LED brightness adjustment:

By short pressing the middle LED button, the brightness of the LED can be adjusted in 6 steps from 100% to completely turning off the LED. The brightness intensity is briefly displayed using LED columns.

RGB LED color adjustment:

Turn ON the RGB function:

- A long press of the middle LED button for 5 seconds activates the color setting mode, and the two middle LEDs on the LED columns light up with the current color.
- Now, with a short press of the LED button, the LED color can be changed. The current color will be displayed on the LED bars.

Turn OFF the RGB function:

- By pressing the middle LED button again for 5 seconds or by briefly pressing the upper or lower button, you save the current LED color.

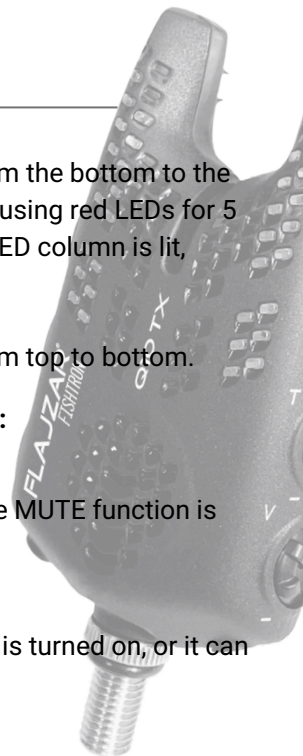

LED Night position (NIGHT function):

Turn ON/OFF NIGHT function:

Short press the lower ALARM button.

The upper LED lights up dimly with the set color.

Activating / deactivating the ALARM function:

Turn ON the ALARM function:

- Long press the lower ALARM button for 2 sec. The activation of the ALARM function is signaled by flashing of the lower LEDs and a deep beep 3 times in a row.
- The infrared barrier is now active at the top on the back of the forks.

If the IR barrier is interrupted by pulling the rod out of the fork of the bite alarm, alarm signal will sound, the LED columns will flash and the bite alarm will send an alarm to the paired receiver. If there is a bite, the IR barrier is deactivated and needs to be switched on again.

When the IR barrier is turned on, the battery consumption is slightly higher. In direct sunlight the function may be limited.

Turn OFF the ALARM function:

- Long press the lower ALARM button. Turning off the ALARM function is signaled by flashing of the lower LEDs and a deep beep 3 times in a row.

When there is a bite recorded, the IR barrier function is automatically turned off.

CONNECT function (range control and sound control from the receiver):

Q10 TX fish bite alarm has a two-way communication function with the RX MAX receiver for range and sound control of the bite alarm from the receiver.

When the CONNECT function is turned on, the battery consumption is slightly higher.

Turn ON the CONNECT function:

- By a very long press of the ON/OFF button for more than 5 sec. with the bite alarm off.
- The LED columns will light up from the center up and down.
- Now the CONNECT function is on and the bite alarm is able to receive commands from the receiver for range and sound control of the bite alarm.

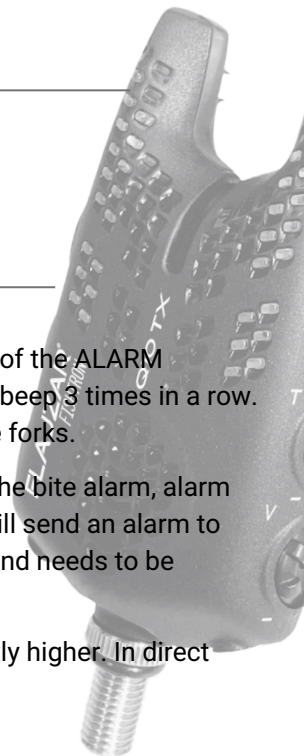

Turn OFF the CONNECT function:

Long press the upper ON/OFF button for 5 seconds, the alarm will turn off.

Sensitivity adjustment

Top S button:

By turning the S knob forward, the lowest sensitivity can be set up to 15 cm with a direction of the fishing-line unwinding. Setting it to the lowest sensitivity of 15 cm includes an automatic sensitivity increase function after a bite - if the alarm detects a bite at this setting, it will automatically adjust to the highest sensitivity with a direction of the fishing-line unwinding (4mm) and remains set until the memory LED goes out. After that, the sensitivity is set to 15 cm back again.

By turning knob S as far back as possible, the lowest sensitivity is set to about 1.5 mm without distinguishing the direction of the fishing-line unwinding

Tone adjustment

Middle T button:

By turning the T knob forward, a deep tone (so-called duck) can be set.

By turning the T knob backwards, you can adjust the high tone. The set tones are transmitted to the receiver.

Volume adjustment

Bottom V button:

By turning the V knob forward, the volume can be reduced until the sounds are turned off completely.

Turn the V knob backwards to increase the volume.

Connector for SWINGER:

The lower two connectors are intended for connecting standard swingers with a JACK 2.5mm connector. The connector is active as long as the memory LED is on.

Battery:

Battery replacement:

It is done by pulling out the cover on the back of the bite alarm.

Battery:

2 pcs LR03 (AAA).

Use only high-quality alkaline or lithium batteries (2x 1.5V).



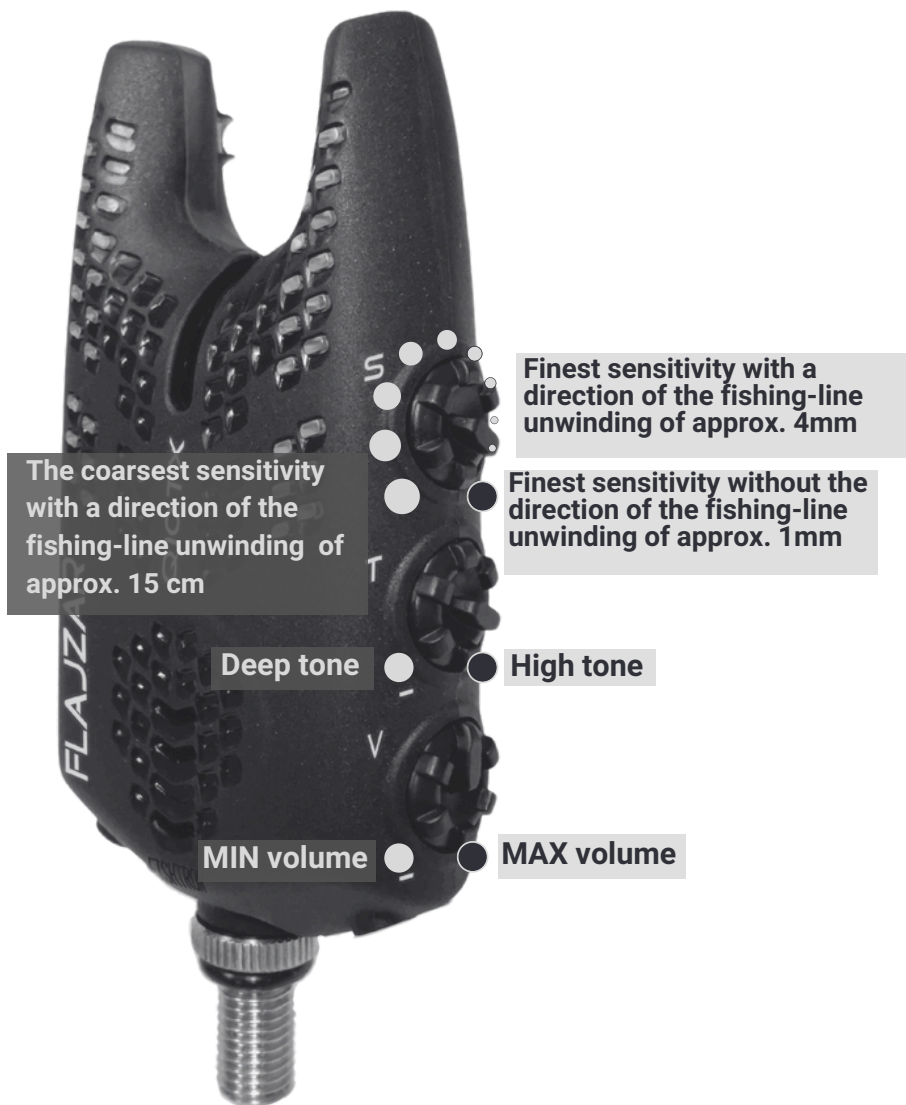

How to achieve the maximum range of the set

The range of the set, bite alarm - receiver, is several hundreds of meters in free space, up to 900 m on flat surfaces. Any terrain unevenness, bank, slope, buildings, cars or other obstacles limit the range. If the current conditions and fishing method allows it, the bite alarm should be placed at least 0.5 meters above the ground (if you have a requirement for extreme range). Carry the receiver with you and if you want to achieve the maximum range, keep it in your top pocket or use a lanyard (it goes under the stainless steel rod in the upper part of the receiver). Do not place the receiver or transmitter on metal objects. Both the bite alarm and receiver should have their antennas facing upwards. Despite the great range of the kit, we urge you to comply with the Fishing Regulations and not to leave the fishing spot at a distance greater than what is allowed by the Fishing Regulations. After installing the beacons, always verify the range in the given location.

Declaration of Conformity

The device complies with EU directives and is issued with a Declaration of Conformity.

Post-warranty service

Post-warranty service is performed exclusively by the czech manufacturer - the company FLAJZAR, s.r.o. It is our utmost effort to help you solve all your problems in the shortest possible time.

Quick email contact in case of problems: obchod@flajzar.cz.

Recycling

Information for users on the disposal of electrical and electronic equipment. The indicated symbol on the product's packaging or in the accompanying documentation means that used electrical or electronic products must not be disposed of together with municipal waste. In order to properly dispose of the product, hand it in at designated collection points, where it will be accepted free of charge.

Battery

Do not throw batteries into fire, do not disassemble, do not short circuit. Do not recharge the batteries.

Manufacturer / service / technical support

FLAJZAR, s.r.o.

Svatoplukova 1199

698 01 Veselí nad Moravou



EU declaration of conformity

Product No.: Q10 TX, RX MAX, ALF4

This Declaration of Conformity is issued under the sole responsibility of the manufacturer:
FLAJZAR, s.r.o., ID: 01616161
with registered office in Veselí nad Moravou, Svatoplukova 1199, zip code 698 01
represented by Vojtěch Páník, managing director

Subject of declaration: FISHTRON Q10 TX signaling device, FISHTRON remote monitoring receiver RX MAX and double-sided alarm sensor FISHTRON ALF 4

Type: Q10 TX, RX MAX, ALF4
Operating frequency band: 868.35Mhz
Vf power: max. 15dBm
Modulation: GFSK
Purpose of use: signaling fish bite using wireless signal transmission

The subject of the statement described above is in accordance with Government Regulation No. 426/2016Coll., which sets technical requirements for radio and telecommunications terminal equipment and Government Regulation No. 481/2012 Coll. on the restriction of the use of certain hazardous substances in electrical and electronic equipment.

and harmonized Czech technical standards applicable to the given type of equipment:

EMC:	ČSN EN 61000-4-2 ed.2 ČSN EN 61000-4-3 ed.4
Radio parameters:	ČSN ETSI EN 300 220-2 V2.4.1 ČSN ETSI EN 300 220-1 V2.4.1
Safety:	ČSN EN 62368-1
RoHS:	ČSN EN 55032 ed.2

and is safe under normal conditions of use and in accordance with the instructions for use. This statement is

issued under the sole responsibility of the manufacturer.

The CE mark has been placed on this product.

Signed for and on behalf

of:

(place and date of issue):

(name, position)

(signature):

Vojtech Páník Brno,

01/02/2024

company executive